

Le cose che hanno fatto l'Italia: innovazione e società

Vittorio Marchis
Politecnico di Torino

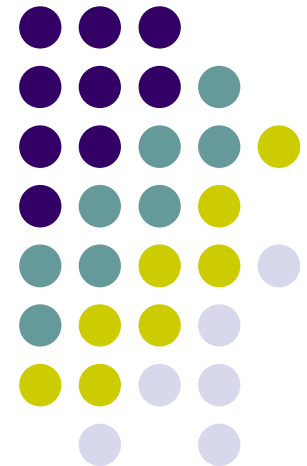

Bianca, regia di Nanni Moretti (1984)



Caro diario, regia di Nanni Moretti (1993)



Vacanze Romane, regia di William Wyler (1953)



The Graduate,
regia di Mike Nichols (1967)



Back to the Future,
regia di Robert Zemeckis (1989)



Non solo la settima arte...

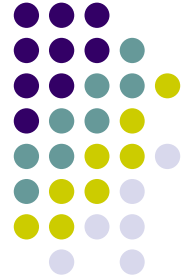

Alfa Spider Duetto, Pininfarina (1961)



DeLorean DMC-12, Giorgetto Giugiaro (1981)



Tante storie... intricate...



Corradino D'Ascanio



... molte cose ... italiane

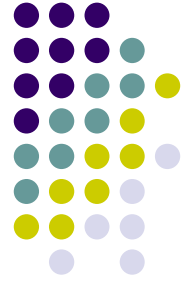

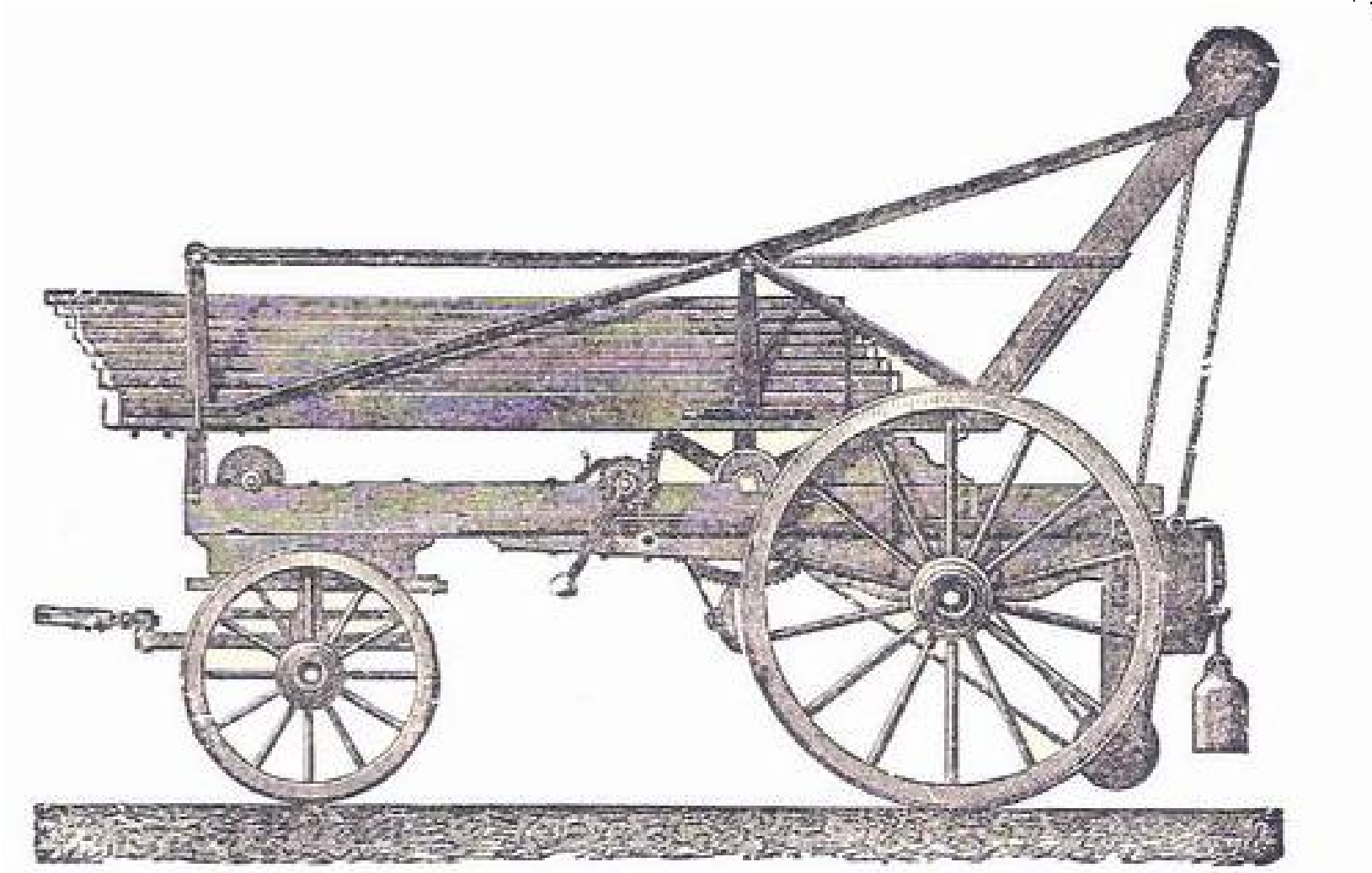
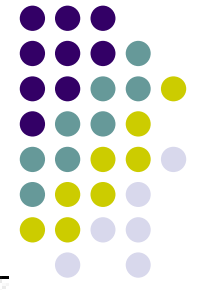

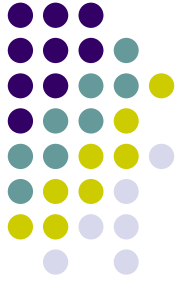
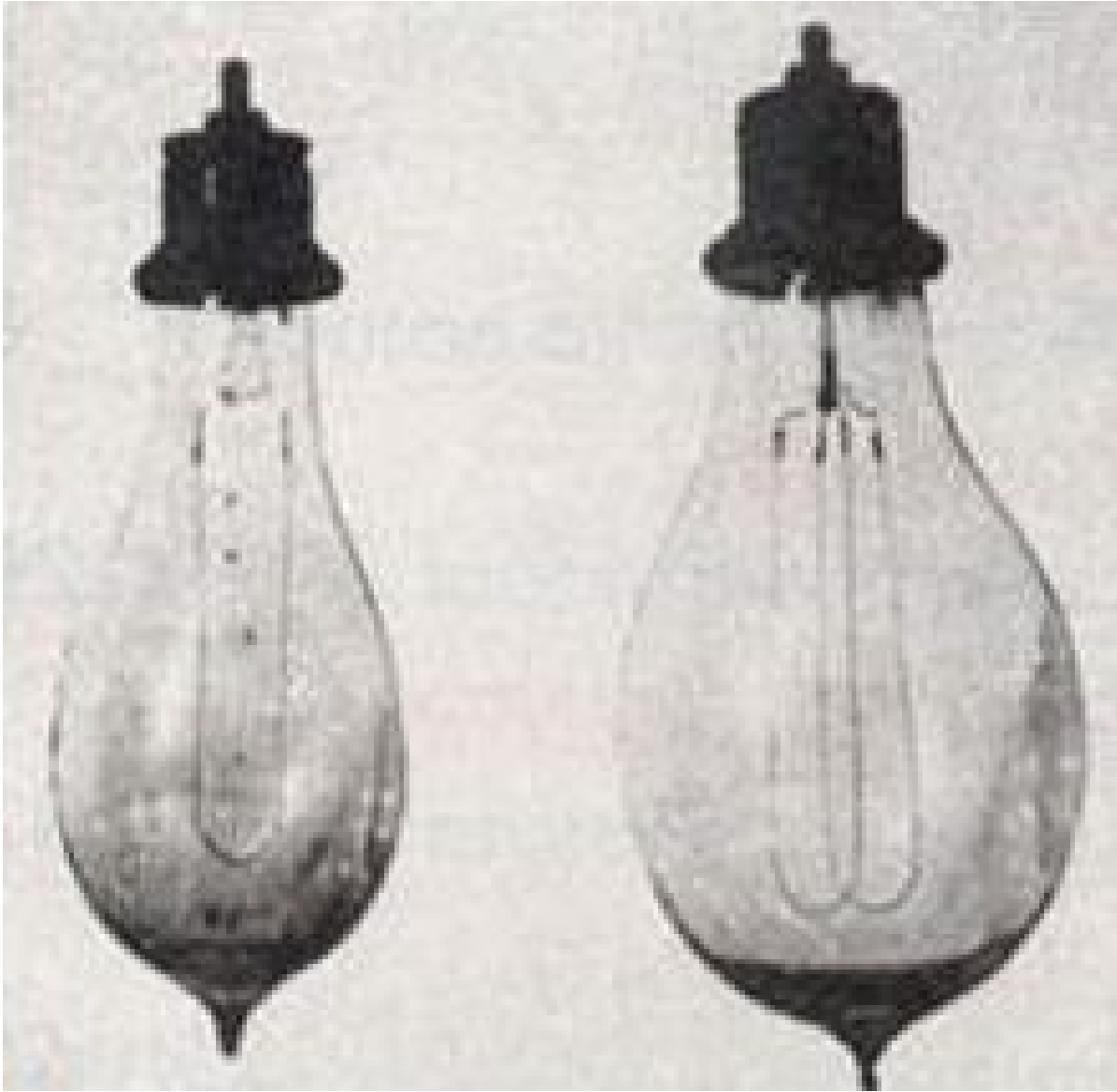



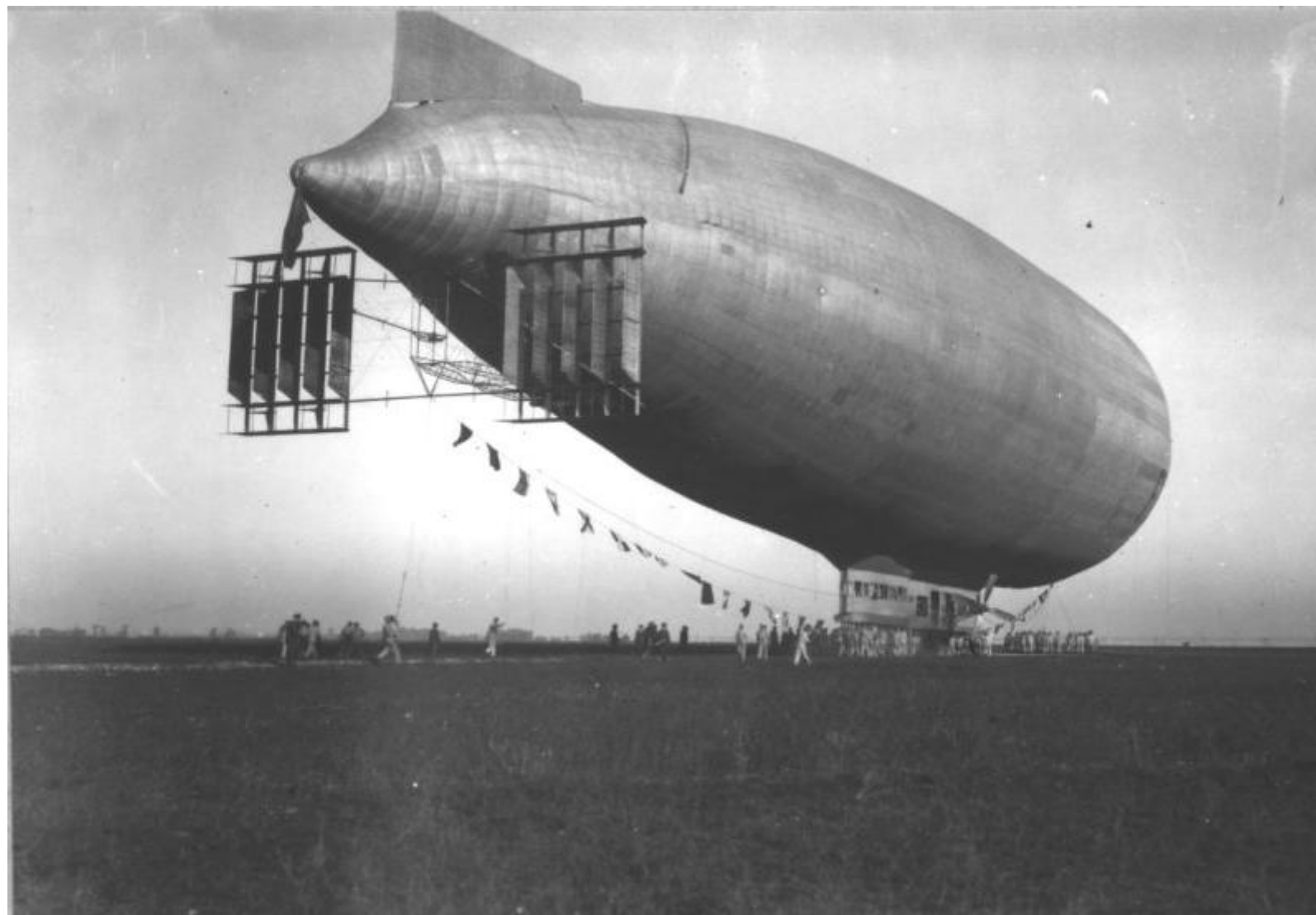
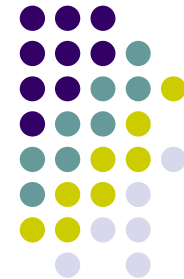

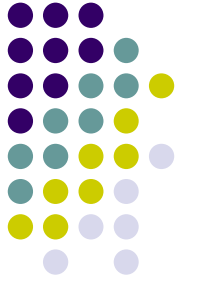



“Nutella” Ferrero

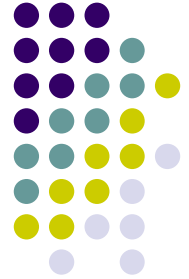

Alle massaie intelligenti

la SUPERCREMA

è un prodotto squisito, genuino, di elevato valore energetico: sviluppa infatti ben **5100** calorie.

LA SUPERCREMA FERRERO

è uno degli alimenti più economici esistenti sul mercato perché, tenuto conto del valore commerciale del recipiente di vetro, un kilogrammo di squisito e sano alimento costa in realtà poco più di 500 lire. La massaia intelligente che sa spendere bene il suo denaro acquista sempre e soltanto

SUPERCREMA FERRERO

Diffidate dalle imitazioni che non vi danno garanzia di un prodotto genuino.

Ferrero
S.p.A.

“Vespa” Piaggio



“Lambretta” Innocenti



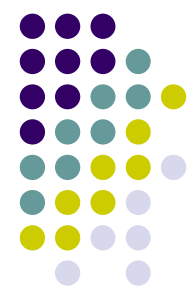



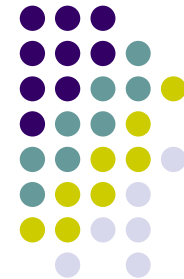

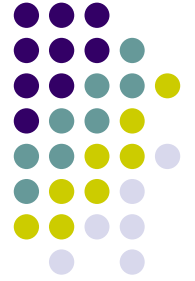



De ruime kleine 4-persoons wagen

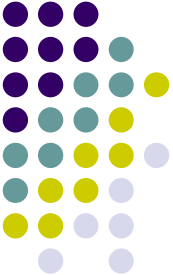



NEW
PX4 COMPACT





le sardomobili
hanno cieli di latta
liberi "chi Ciao"

-Chi Ciao- canta la ballata dell'arcobaleno: scrive blu con l'acqua fresca, scrive rosso con le rose, scrive verde con le foglie.... Anche tu lo sai: le sardomobili hanno 4 ruote ma vorrebbero averne 2. Come il Ciao.



PIAGGIO cambia il mondo in due ruote

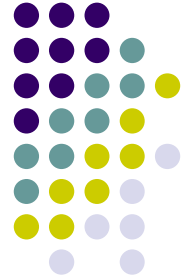

Un “teatro” internazionale: l’ «US Patent Office»

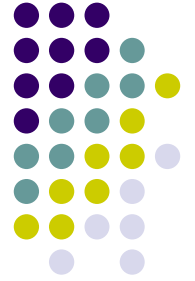

Le “cose” italiane varcano
l’Atlantico...

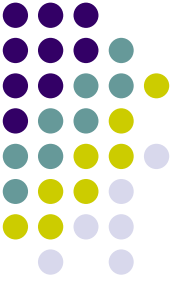

Clemente Masserano, 1851

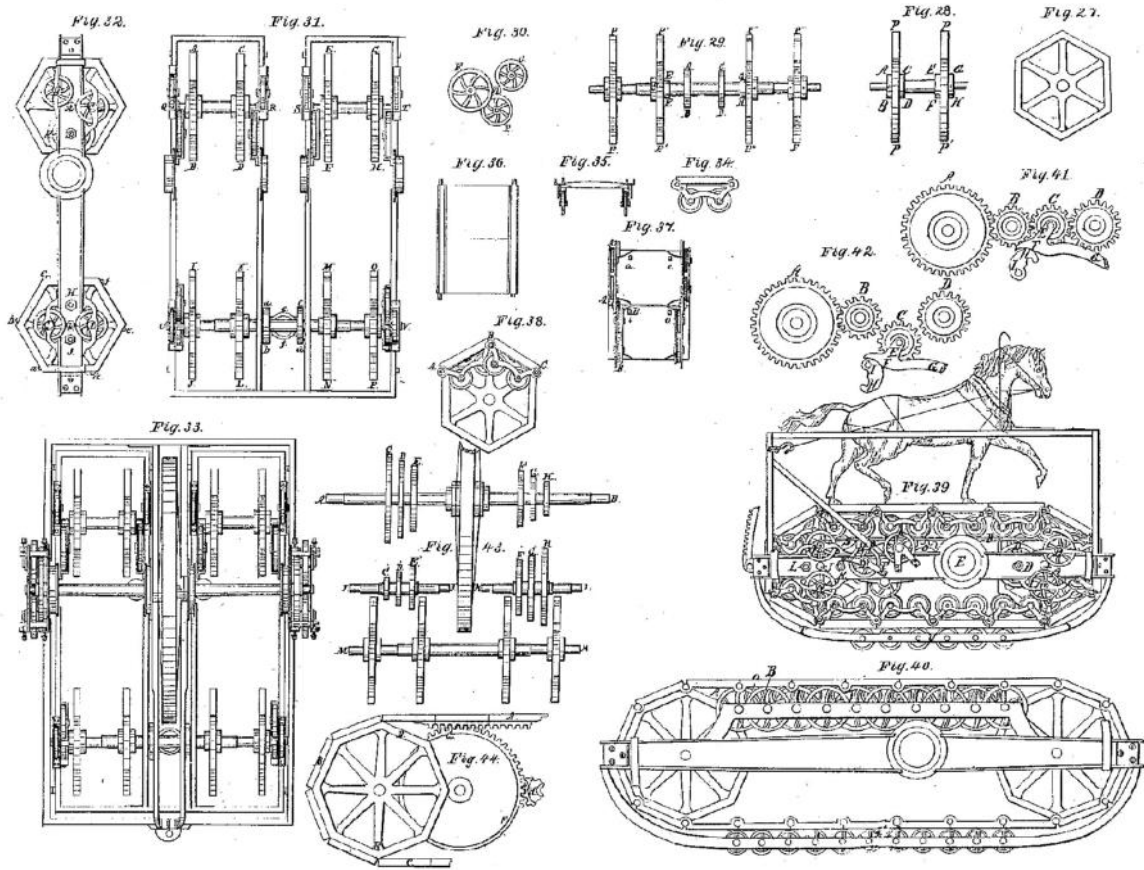

No. 8,417.
LOCOMOTIVE MOVED BY THE POWER OF ANIMALS.
Patented Oct. 7, 1851.

C. MASSERANO
10 Sheets—Sheet 7.

FOR ADAMS & CO. ARCHITECTS, WASHINGTON, D. C.

Giovanni Caselli, 1855

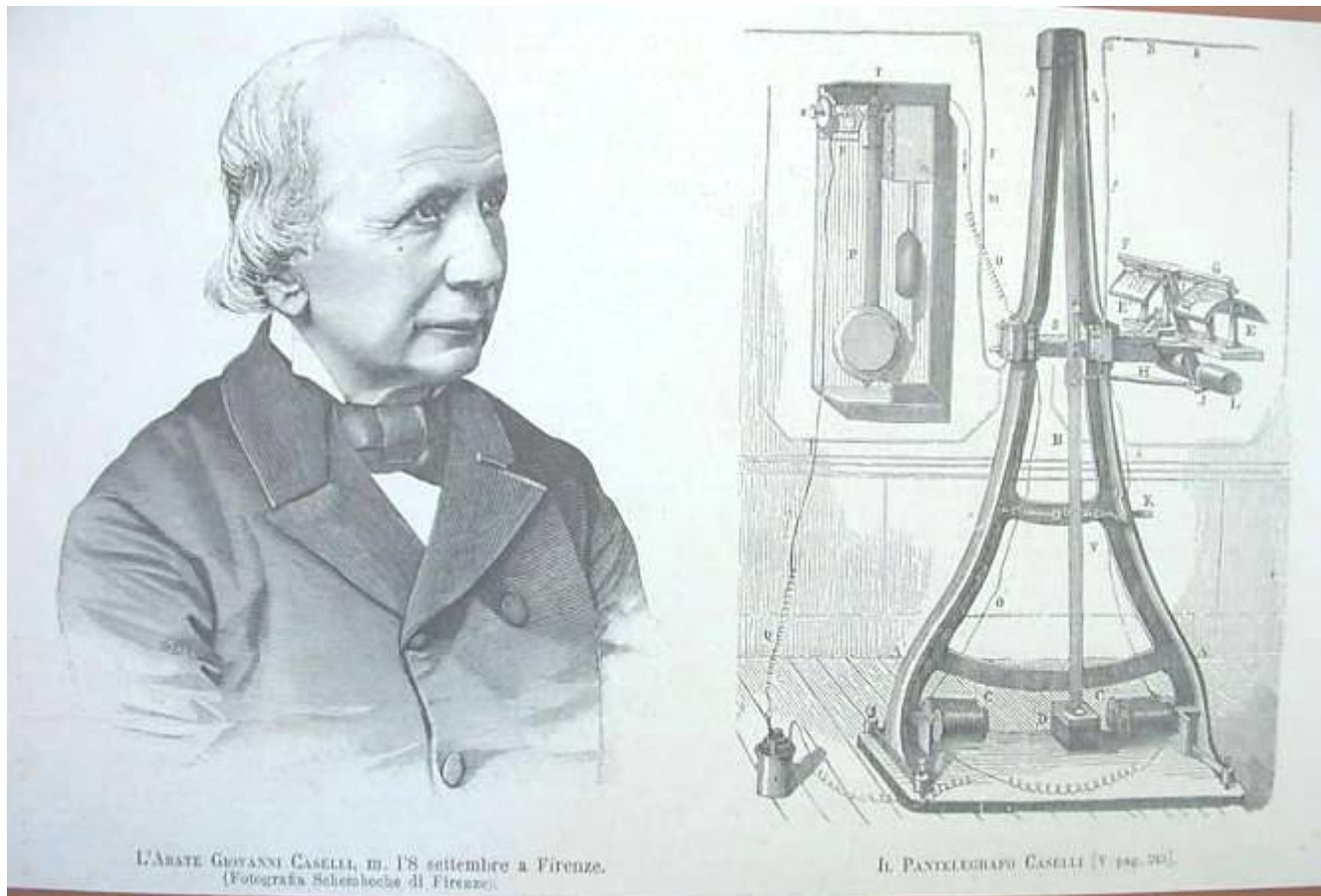

L'ARTE GIOVANNI CASELLI. III. 18 settembre a Firenze.
(Fotografia Schenboche di Firenze).

II. PANTOGRAFO CASELLI (V. 186-20).

G. Casselli, 2 sheets, sheet 1.
Telegraphic Apparatus.
 No 31,563. Patented Feb. 3, 1863.

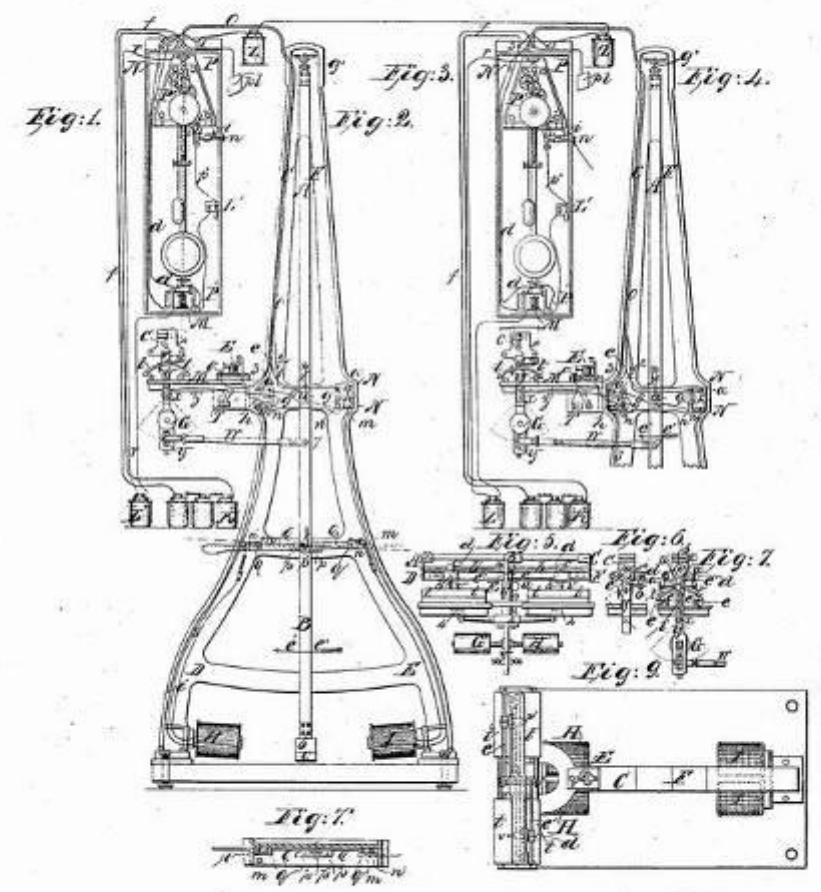

Witnesses:
 [Signature]
 [Signature]

Inventor:
 G. Casselli
 by [Signature]

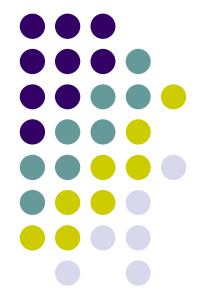



Tommaso Agudio, 1863

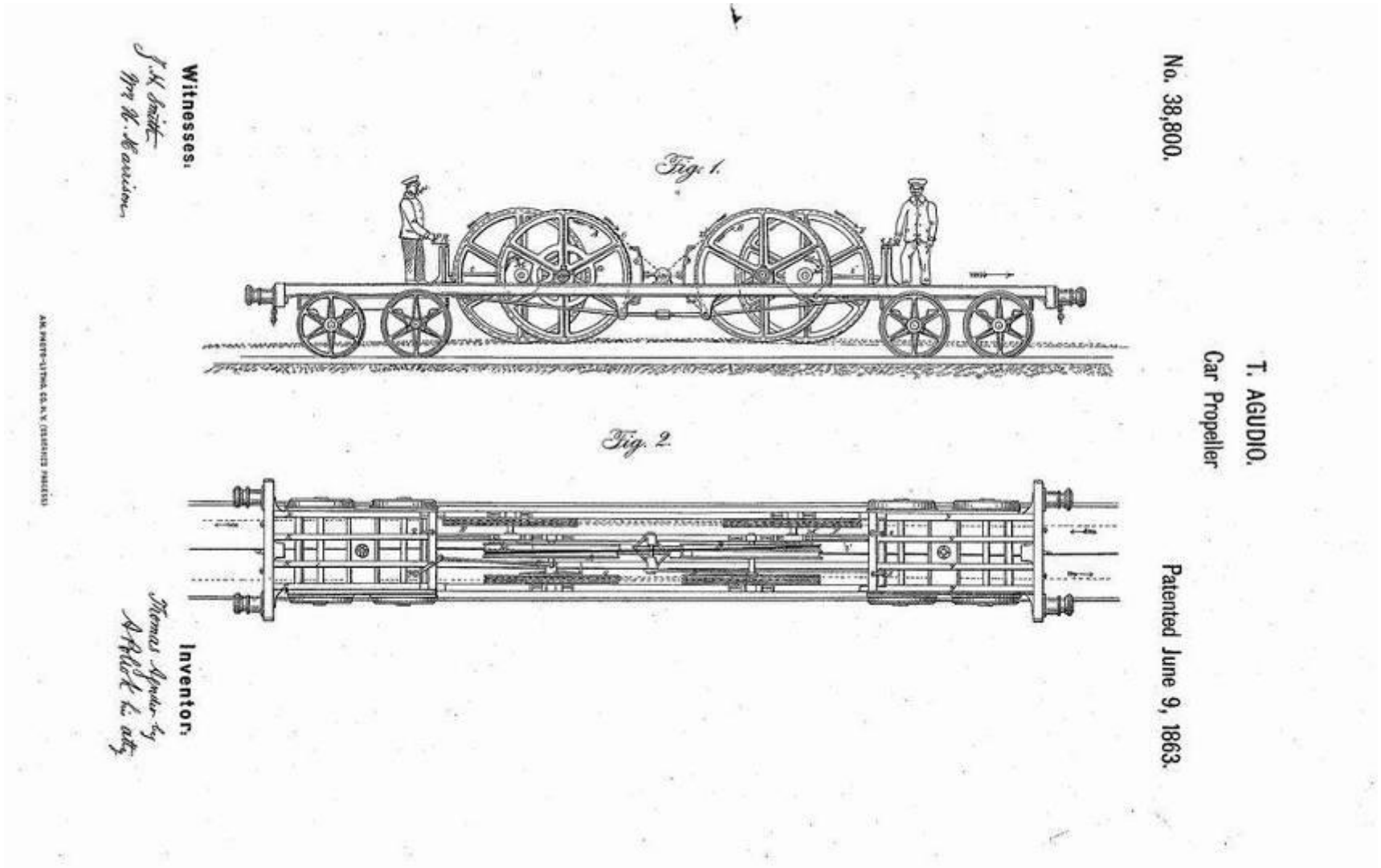

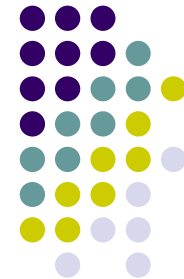

Gaetano Bonelli, 1864

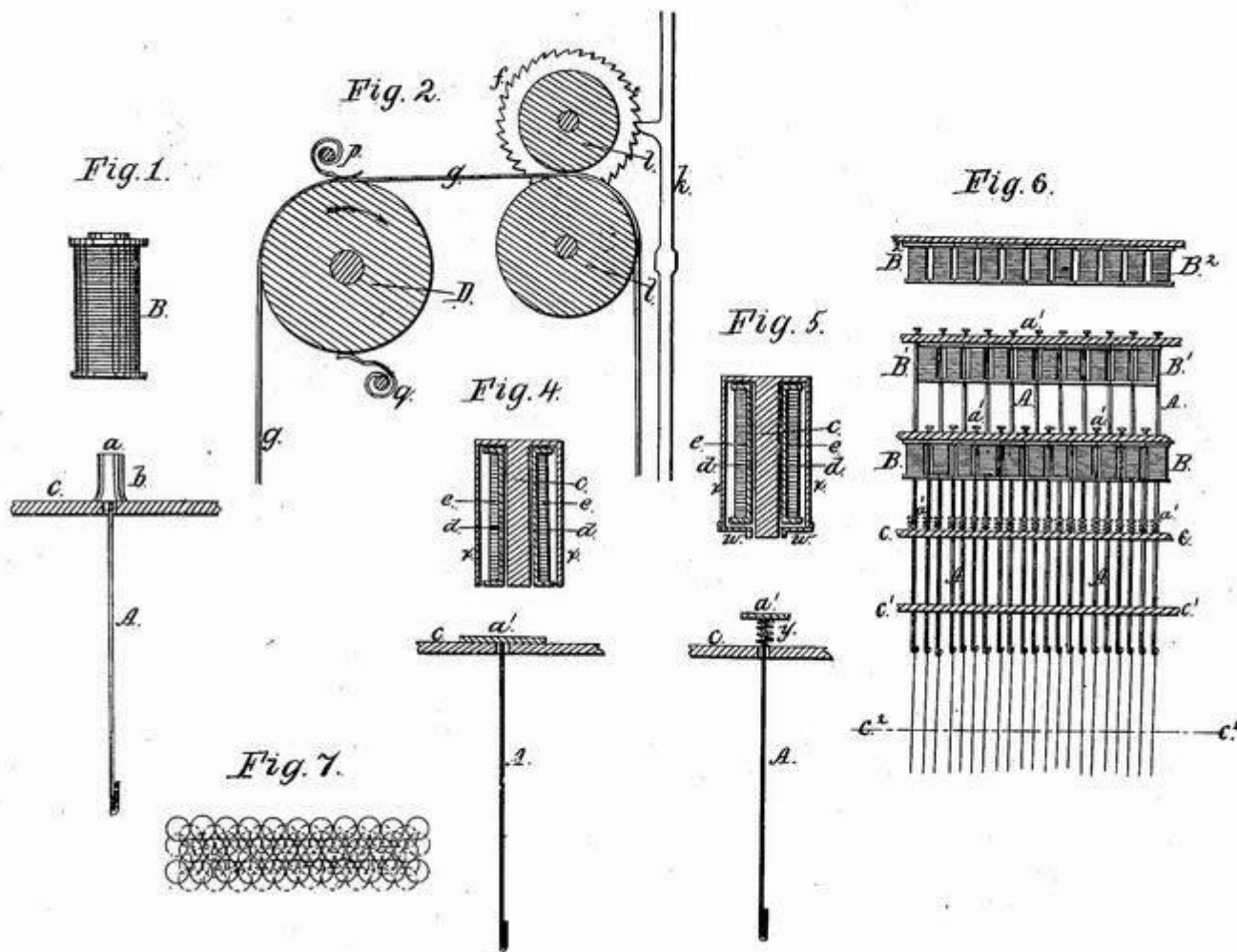

No. 12,050.

G. BONELLI,
ELECTRICAL LOOM.

Patented Dec. 12, 1854.

4 Sheets—Sheet 1.